

08420080050

D603/555 4.6 HDG SQR NECK BLT OV M8X50

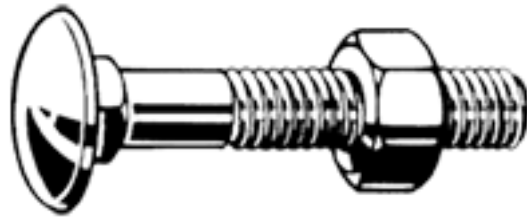

Brand	-
UBB Code	951351381219
UNSPSC Code	31161612
EAN Code	8715492560926
Thread	Metric thread
Class	≥4.6
Material	Steel
Surface treatment	Hot dip galvanized

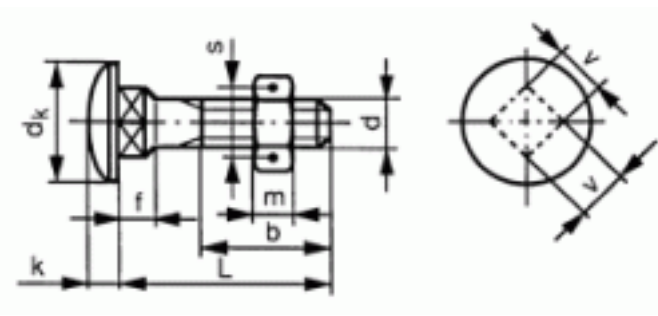

L	50
d	M8
Packaging (Piece)	200.0



Copyright Fabory Group