

WSK Thermokon 314602 / 430630 / 430821 / 1510683

Battery free wireless keypad and remote control



Applications

- wire less keypad with with OPEN / CLOSE / STOP function
- remote control with OPEN / CLOSE / STOP function
- secondary priority when connecting to smoke units
- battery free
- less cabling

The ventilation keypad and remote control are used for the manual opening and closing of electrically operated windows, smoke vents or light domes.

The ventilation keypad signal and the remote control signal have second priority in the smoke unit, meaning the signals from smoke detectors, smoke ventilation switches and external smoke alarm units have first priority.

The receiver, which receive signals from the keypad and remote control, can be connected to all WindowMaster control units and smoke ventilation panels. The receiver can receive up to 10 identical signals and thus can up to 10 keypads/remote controls be connected to the receiver. Is there more than one type of signal two receivers are to be used – please see application examples 1 and 2 on page 3.

Keypads and remote controls are battery-free, since they self power the required energy when used.

WSK Thermokon – 430630

Keypad with 2 channels. For the operation of one motor lines. To be used with one receiver type WSK Thermokon – 1510683.

WSK Thermokon – 430821

Keypad with 4 channels. For the operation of two motor lines. To be used with two receivers type WSK Thermokon – 1510683.

WSK Thermokon – 314602

Remote control with 4 channels. For the operation of two motor lines. To be used with two receivers type WSK Thermokon – 1510683.

WSK Thermokon – 1510683

Receiver SRO-VA for WSK Thermokon remote controls and wire less keypads. Up to 10 keypads/remote controls be connected to the receiver.

The receiver is connected to a control unit or smoke ventilation panel.

The receiver has a programmable operation time (opening/closing time), which is preset to 10 sec.

The receiver has three options for operating the open / close / stop function on the keypad and remote control:

Option 1 (preset)

Long press: opens/closes the actuators in the preset operation time or until stop is pressed

Short press: stop

Option 2

Short press: opens/closes the actuators in the preset operation time or until stop is pressed

Short press: stop

Option 3 (deadman function)

Opens/closes the actuators as long as the button is pressed, but no longer than the preset operation time.

Technical specifications

WSK Thermokon 430630 / 430821 – wire less keypads with 2 or 4 channels

Function	Keypads for operation of one or two motor lines. 2-channel: operation of one motor line, used with one receiver WSK Thermokon – 1510683 4-channel: operation of two motor lines, used with two receivers WSK Thermokon – 1510683
Mounting	Glued (double-sided mounting film enclosed) or screwed onto flat surface
Material	Plastic
Colour	White
Size	61 x 61 x 15mm (W x H x D)
Delivery includes	Keypad and double-sided adhesive foil

WSK Thermokon 314602 – remote control with 4 channels

Function	Remote control for operation of two motor lines. Used with two receivers WSK Thermokon – 1510683
Material	Plastic
Colour	Black
Size	50 x 83 x 25mm (W x H x D)
Weight	50g
Delivery includes	Remote control

WSK Thermokon 1510683 – receiver SRO-VA

Function	The receiver receives signals from WSK Thermokon keypads and remote controls. With programmable operation time as well as three operation modes for the keypads and remote controls.
Supply voltage	24V from a WindowMaster control unit or smoke ventilation panel
Standby consumption	1,5W
IP rating	IP20
Mounting	Screwed onto flat surface The receiver can also be hidden in a box (not supplied by WindowMaster)
Material	ABS
Colour	Red
Size	71 x 48 x 35mm (W x H x D)
Delivery includes	Receiver

Generally for keypads, remote control and receiver

Range/operation	30m: when visual contact or through max. 5 wood walls 20m: when max 2 brick walls 10m: when reinforces concrete or through max. 1 ceiling
Receiving frequency	868 MHz
Operating conditions	-20°C - +60°C, max. 95% relative humidity (not condensing), for indoor use
Note	We reserve the right to make technical changes

Application example 1

The receiver as well as the window actuator(s) are connected to a control. The control can be either a control unit or a smoke ventilation panel.

The window(s) is operated on the 2-channel wireless keypad.

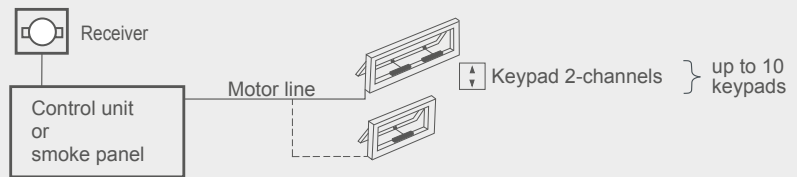

Application example 2

The receivers and window actuators are connected to a control. The control can be either a control unit or a smoke ventilation panel.

The windows are operated on the wireless 4-channel keypad or on the remote control

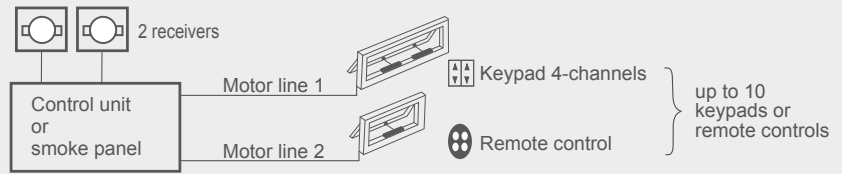

Dimensional drawing: WSK Thermokon – 1510683 receiver SRC-DO2

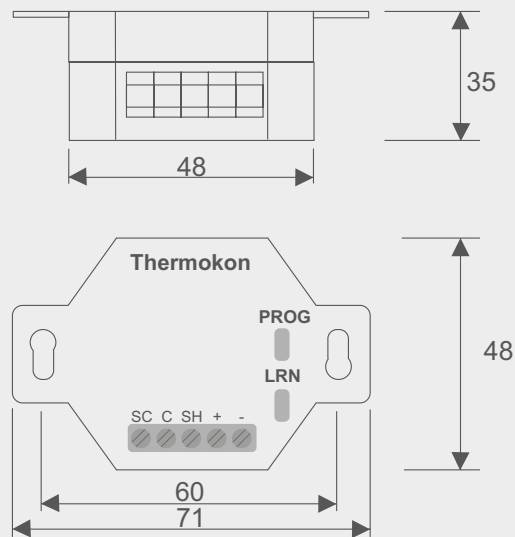

Connection to control units (examples)

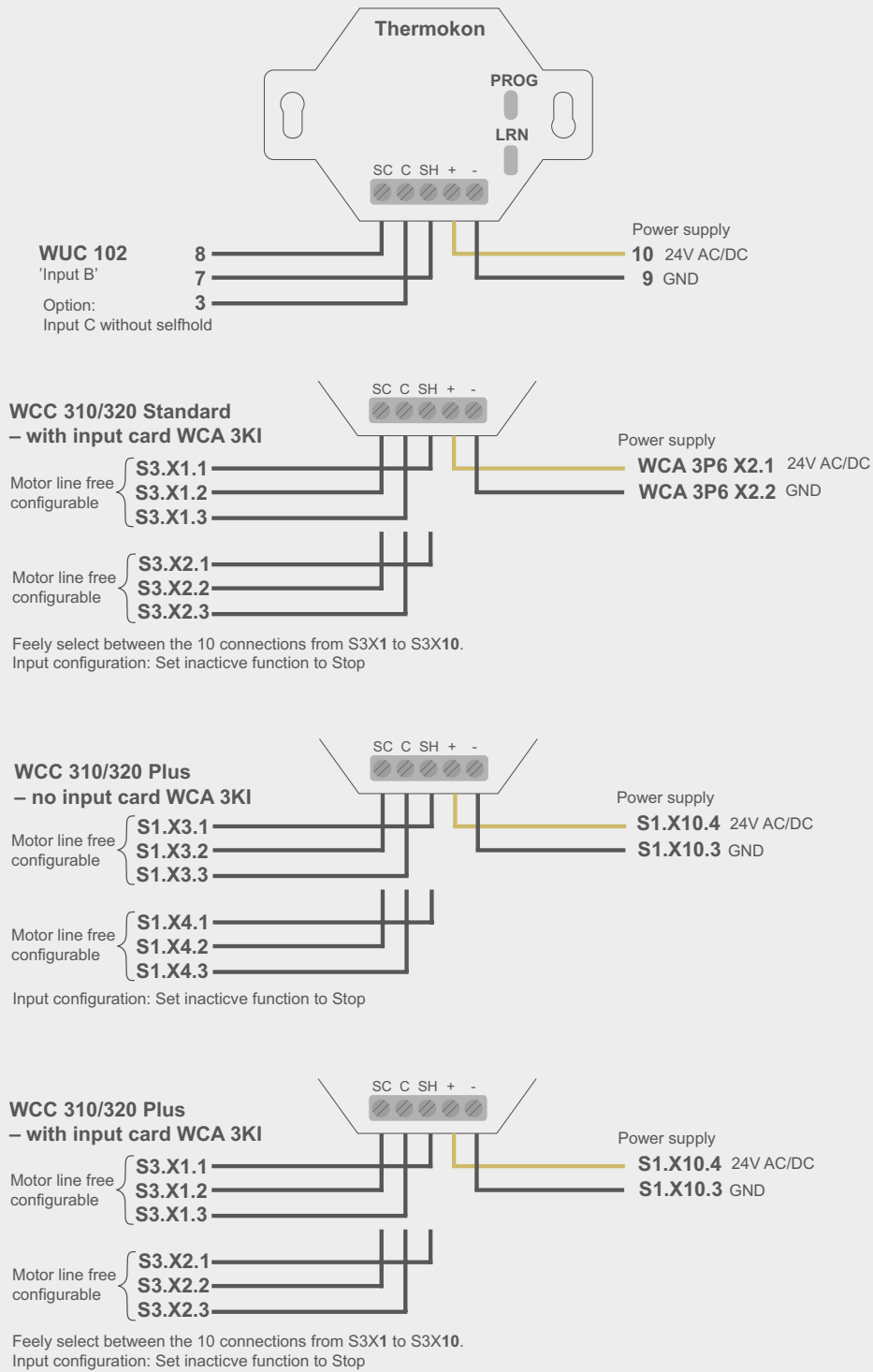

Connection to smoke control panels – CompactSmoke™ (examples)

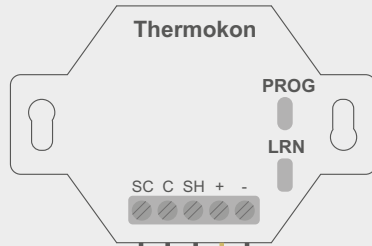

WSC 204

SW 2/2 = ON



When closing the windows, the smoke panel will close them fully. To stop the closing press 'Open'.

WSC 310/320 Standard

DIP 1.1 = OFF
DIP 1.2
DIP 1.3

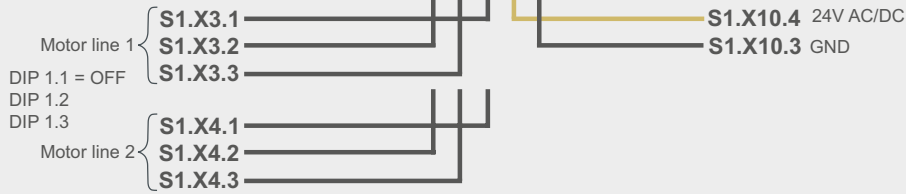

**WSC 310/320 Plus
– no input card WCA 3KI**

Motor line free
configurable

Motor line free
configurable

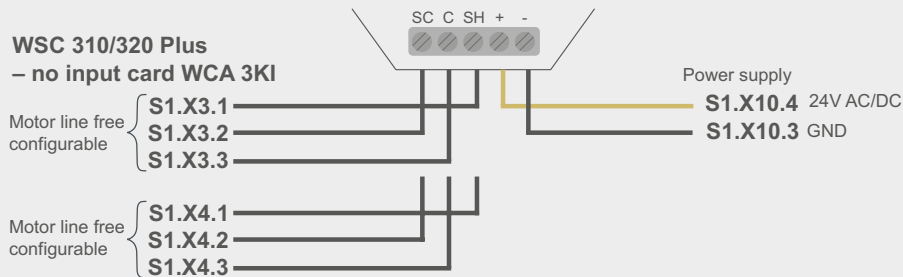

Input configuration: Set inactive function to Stop

**WSC 310/320 Plus
– with input card WCA 3KI**

Motor line free
configurable

Motor line free
configurable

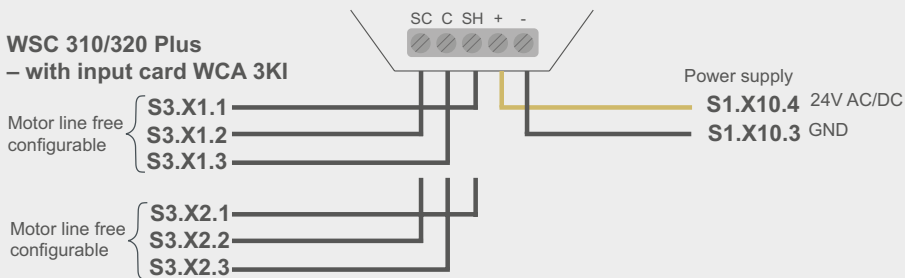

Feel free to select between the 10 connections from S3X1 to S3X10.
Input configuration: Set inactive function to Stop

Battery free wireless keypad and remote control

Connection to smoke ventilation panel – FlexiSmoke™ (examples)

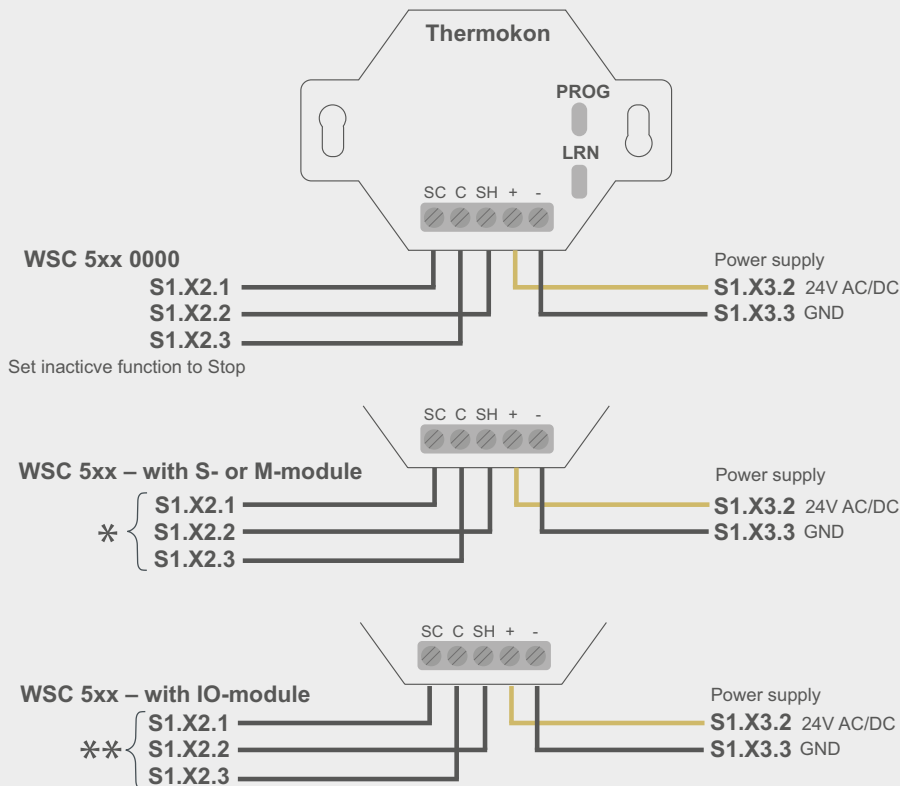

* Alternatively it can be connected on the S-module respectively the M-module. Depending on where the module(s) is located, the connection can be made on S3, S4 or S5 on X5.1, X5.2, X5.3
 Set inactive function to Stop

** Alternatively it can be connected on the IO-module. Depending on where the module(s) is located, the connection can be made on S3, S4 or S5 on X4.1 or X4.4 or X4.7, X4.2, X4.5, X4.8, X4.3, X4.6, X4.9
 Set inactive function to Stop

Items	Item number
Keypad, 2-channel, wireless, for control of one motor line To be used with one receiver type WSK Thermokon – 1510683	WSK Thermokon – 430630
Keypad, 4-channel, wireless, for control of two motor lines To be used with two receivers type WSK Thermokon – 1510683	WSK Thermokon – 430821
Remote control, 4-channel, for control of two motor lines To be used with two receivers type WSK Thermokon – 1510683	WSK Thermokon – 314602
Receiver SRO-VA for WSK Thermokon wireless keypads and WSK Thermokon remote controls	WSK Thermokon – 1510683

Accessories	Item number
Antenna, internal: SRE-Repeater UP, 230V	WSK Thermokon – 556736
Antenna, external: SRE-Repeater / B, 230V	WSK Thermokon – 593830
Antenna extender 10m	WSK Thermokon – 257206