

12410080001

D985 |10| ZPL HX LCKNT/INS M8

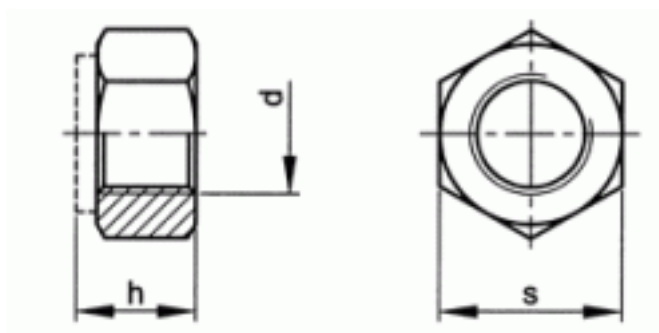

Brand	-
UBB Code	950355542784
UNSPSC Code	31161727
EAN Code	8715492578501
Driving features	hexagon
Thread	Metric thread
Class	10
Material	Steel
Surface treatment	Zinc plated



s	13
h	8
P	1,25
d	M8
Packaging (Piece)	250.0



Copyright Fabory Group