

12410060001

D985 |10| ZPL HX LCKNT/INS M6

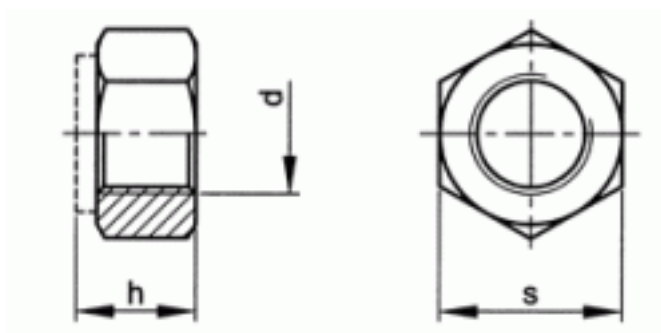

Brand	-
UBB Code	950355542602
UNSPSC Code	31161727
EAN Code	8715492578495
Driving features	hexagon
Thread	Metric thread
Class	10
Material	Steel
Surface treatment	Zinc plated



s	10
h	6
P	1
d	M6
Packaging (Piece)	250.0



Copyright Fabory Group