

12410100001

D985 |10| ZPL HX LCKNT/INS M10

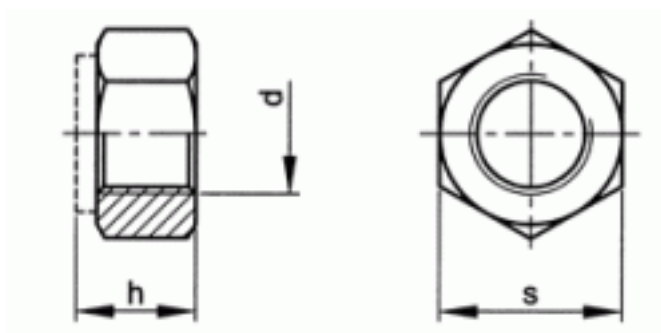

Brand	-
UBB Code	950355542867
UNSPSC Code	31161727
EAN Code	8715492578518
Driving features	hexagon
Thread	Metric thread
Class	10
Material	Steel
Surface treatment	Zinc plated



s	17
h	10
P	1,5
d	M10
Packaging (Piece)	200.0



Copyright Fabory Group