

04190140001

D934 |12| HX NT M14

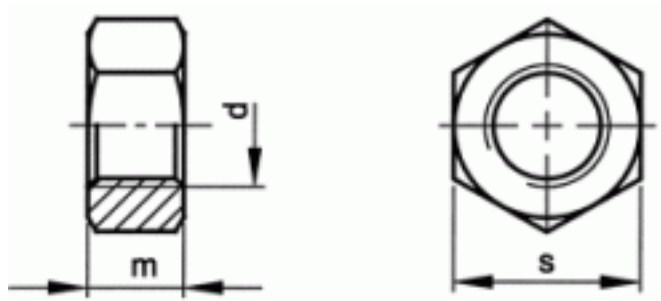

Brand	-
UBB Code	950355327129
UNSPSC Code	31161727
EAN Code	8715492123152
Driving features	hexagon
Material	Steel
Class	12
Thread	Metric thread



s	22
m	11
P	2
d	M14
Packaging (Piece)	100.0



Copyright Fabory Group