

0412020001

D934 |10| HX NT M20

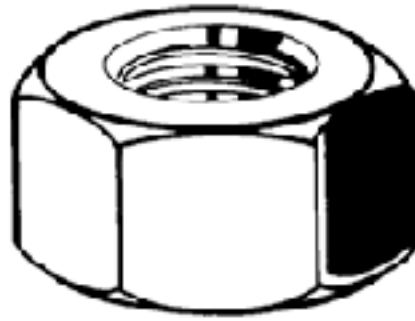

Brand	-
UBB Code	950355043239
UNSPSC Code	31161727
EAN Code	8715492119551
Driving features	hexagon
Material	Steel
Class	10
Thread	Metric thread

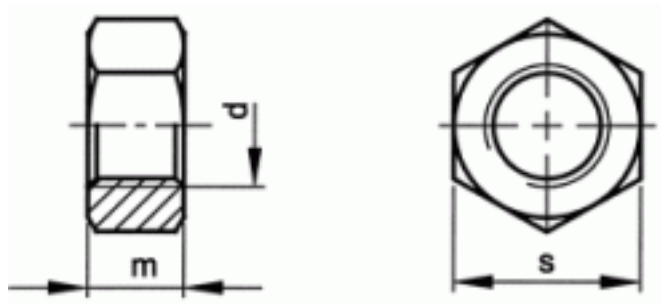

s	30
m	16
P	2,5
d	M20
Packaging (Piece)	50.0



Copyright Fabory Group