

12300050001

D985 |5| ZPL HX LCKNT/INS SP M5

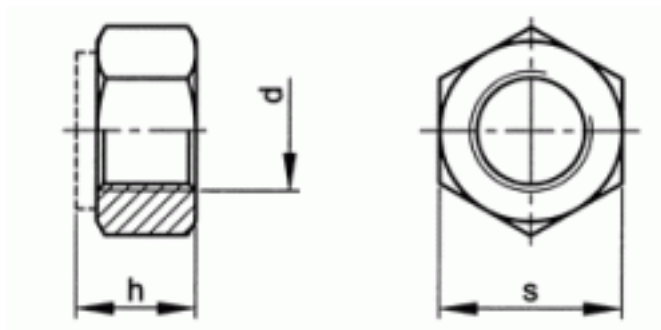

Brand	-
UBB Code	950355115755
UNSPSC Code	31161727
EAN Code	8715492576828
Driving features	hexagon
Thread	Metric thread
Class	≥ 5
Material	Steel
Surface treatment	Zinc plated



s	8
h	5
P	0,8
d	M5
Packaging (Piece)	250.0



Copyright Fabory Group