

12300120001

D985 |5| ZPL HX LCKNT/INS SP M12

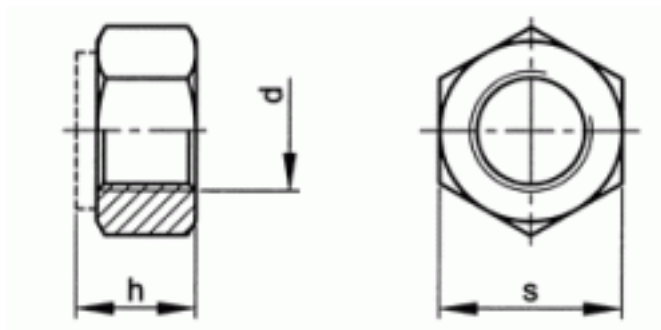

Brand	-
UBB Code	950355116258
UNSPSC Code	31161727
EAN Code	8715492576880
Driving features	hexagon
Thread	Metric thread
Class	≥ 5
Material	Steel
Surface treatment	Zinc plated



s	19
h	12
P	1,75
d	M12
Packaging (Piece)	100.0



Copyright Fabory Group